

PTAC WIRELESS KITS (DT01*, DS01*, DD01*) INSTALLATION INSTRUCTIONS

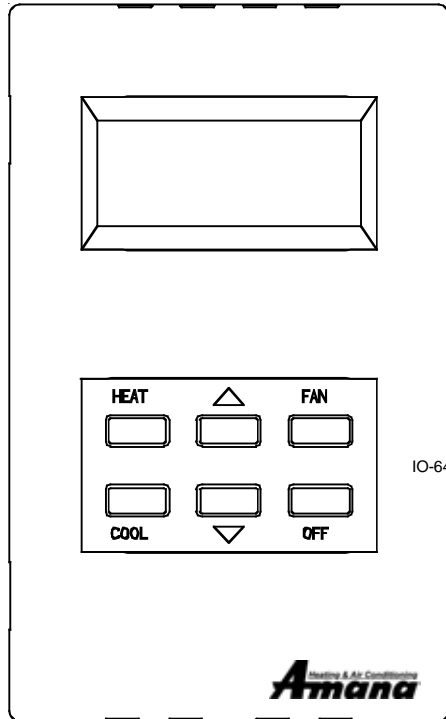

DS01*

IO-644C-IO-644C-092007-4

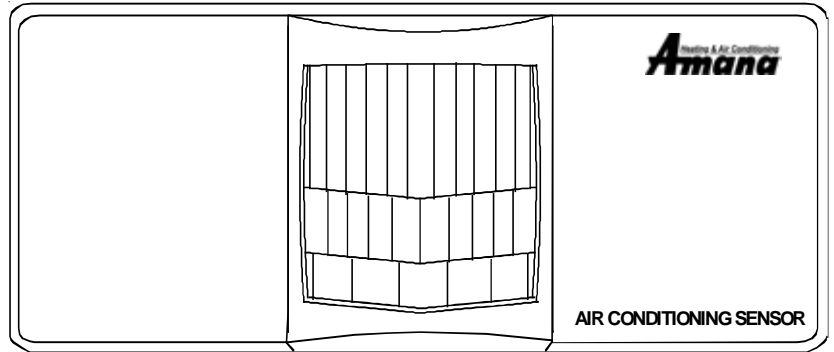

AIR CONDITIONING SENSOR

DD01*

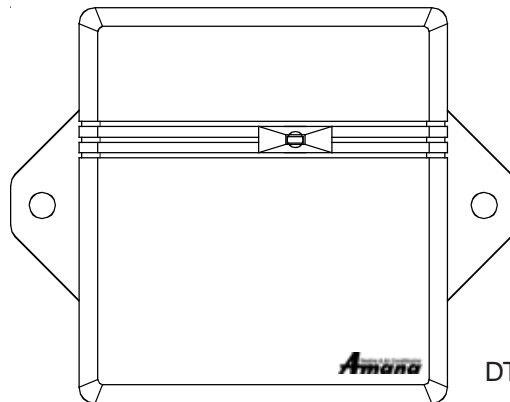

DT01*

The following installation instructions are for a typical installation.
Please contact your PTAC salesperson
for additional assistance and explanation prior to ordering materials or cutting openings.

USE ONLY ONE DD01* PASSIVE INFRARED MOTION SENSOR (PIR) DOOR SWITCH COMBINATION DEVICE AND/OR ONE DS01* TO ONE DIGISMART PTAC UNIT.

ATTENTION INSTALLING PERSONNEL

As a professional installer you have an obligation to know the product better than the customer.
This includes all safety precautions and related items.

Prior to actual installation, thoroughly familiarize yourself with this Instruction Manual.

Pay special attention to all safety warnings. Often during installation or repair it is possible to place yourself in a position which is more hazardous than when the unit is in operation.

Remember, it is **your** responsibility to install the product safely and to know it well enough to be able to instruct a customer in its safe use.

Safety is a matter of common sense...a matter of thinking before acting.

Most dealers have a list of specific good safety practices...follow them.

The precautions listed in this Installation Manual are intended as supplemental to existing practices.

However, if there is a direct conflict between existing practices and the content of this manual, the precautions listed here take precedence.



Antenna Installation For DT01* Kit

A DT01* antenna must be installed to the PTAC to allow operation of either the DS01* remote RF thermostat or a DD01* combination PIR motion sensor and door switch.

! WARNING

HIGH VOLTAGE
DISCONNECT ALL POWER BEFORE SERVICING OR INSTALLING THIS KIT. MULTIPLE POWER SOURCES MAY BE PRESENT. FAILURE TO DO SO MAY CAUSE PROPERTY DAMAGE, PERSONAL INJURY OR DEATH. THE "OFF" SWITCH DOES NOT DISCONNECT ALL POWER TO THE UNIT.



Preparation

1. Disconnect power to the unit by unplugging the power cord at the wall outlet or subbase, or disconnect power at the fuse box or circuit breaker.
2. If the cabinet front is screwed to the chassis, remove the 1/4" screw (or screws) located behind the inlet grille. Pull the inlet grille forward from the top of the grille to access screw(s).

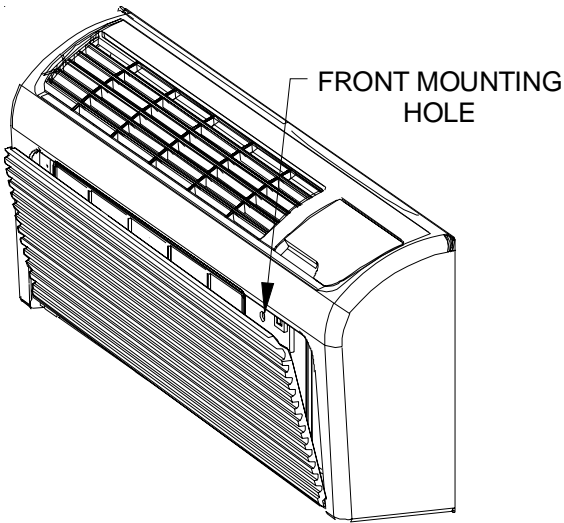

3. Remove cabinet front from chassis by tilting the bottom of the front forward, lifting slightly up and forward.
4. Mount the antenna as high up on the control panel as possible and as far to the right as possible in a location that will not interfere with the reinstallation of the PTAC polymer room front. Mark holes for screw location. Remove antenna housing and drill two 1/8" holes where marked.

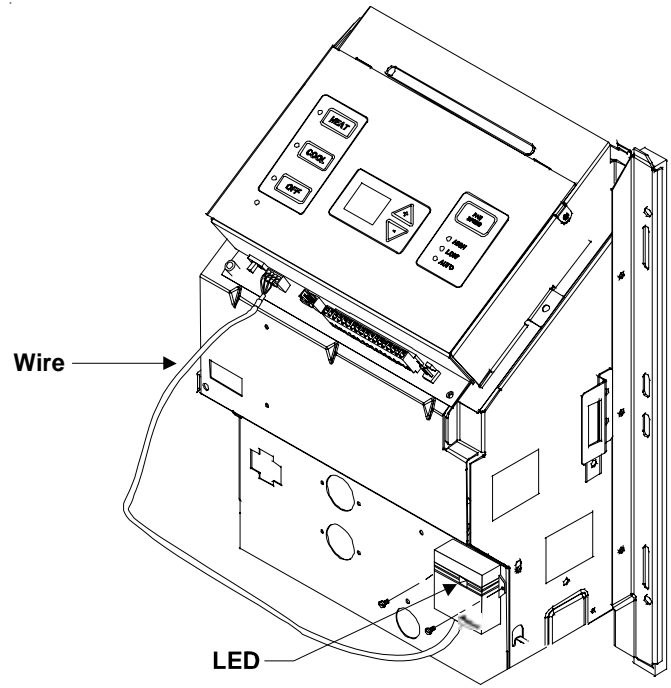

DT01* Mounting

5. Remove antenna cable and route cable through opening in bottom of antenna housing.
6. Mount antenna housing with two screws as shown in figure. (**NOTE:** The Amana® brand logo should be in the lower right hand corner).
7. Plug wire harness from antenna into connector on the control board to the right of the master switch, being careful not to bend and/or break the wires when you connect the cable to the PTAC. Gently push into place with your thumb nails.
8. Restore power to the PTAC unit.
9. Reinstall the polymer room cover.

NOTE: The LED must be oriented at the **top** of the antenna housing for proper unit operation.

Thermostat Installation for DS01* Kit

NOTE: A DT01* must be installed in the PTAC unit for the DS01* to be operable.

Skip these steps if not installing.

1. Select thermostat mounting location about five feet above the floor, on an inside wall, out of direct sunlight, away from sources of radiant heat (lamps, fireplaces, heating and air conditioning equipment, etc.), away from windows or door to the outside, and avoid areas with poor air circulation. Ensure location is out of the path of foot traffic where a person might accidentally bump into the thermostats and damage the device.

- .2. Remove thermostat from mounting plate by pulling apart.
 3. Place thermostat mounting plate against the wall at desired location and mark placement of mounting holes.
 4. If mounting in drywall, tap plastic anchors into wall. For other surfaces, drill a 3/16" hole.
 5. Screw mounting plate to the wall. **DO NOT SNAP THERMOSTAT INTO PLACE UNTIL AFTER BINDING PROCESS.** See *Binding Instructions* on page 5.
 6. Install two (2) AAA batteries (included) into the back of the thermostat. Terminals are marked "+" and "-" for polarity.
2. Mount the back plate on the door trim directly above the door using the enclosed screws. Mount the DD01* as low as possible on the door frame to be as close to the moving part of the door as possible with out interfering with the door opening or closing. Chose a location for mounting the back plate that will provide good coverage of the PIR for motion into the room. Make sure that the DD01* will not interfere with the normal opening and closing of the door.
- DO NOT SNAP MOTION SENSOR IN PLACE UNTIL AFTER BINDING PROCESS.**
- See page 5 for Binding Instructions.*

Mounting Sensor/Door Magnet Installation for DD01* Kit

A DT01* must be installed in the PTAC unit for the DD01* to be operable.

Skip these steps if not installing.

1. Remove motion sensor from mounting plate by pulling apart.

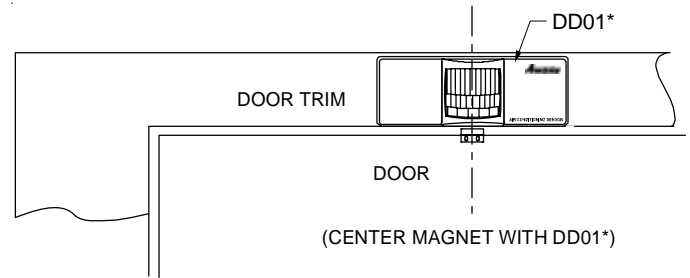

DD01* Mounting

3. Install two (2) AAA batteries (included) into the back of the thermostat. Terminals are marked "+" and "-" for polarity.

Door Magnet Installation

Mount the door magnet holder on the front of the door where it will be as close as possible to the bottom of the motion sensor but no more than 1/8" from the bottom center of the motion sensor (DD01*) when the door is closed.

Select the correct slot in the magnet holder (there are three slots) to obtain 1/2" from back of sensor mounting plate to the center of the magnet. (If you can easily slide a business card between the magnet and the DD01* sensor, unit is properly placed vertically.)

Screw in place with the 2 screws provided. Open and close the door to make sure that the magnet holder and motion sensor will not interfere with normal opening and closing of the door.

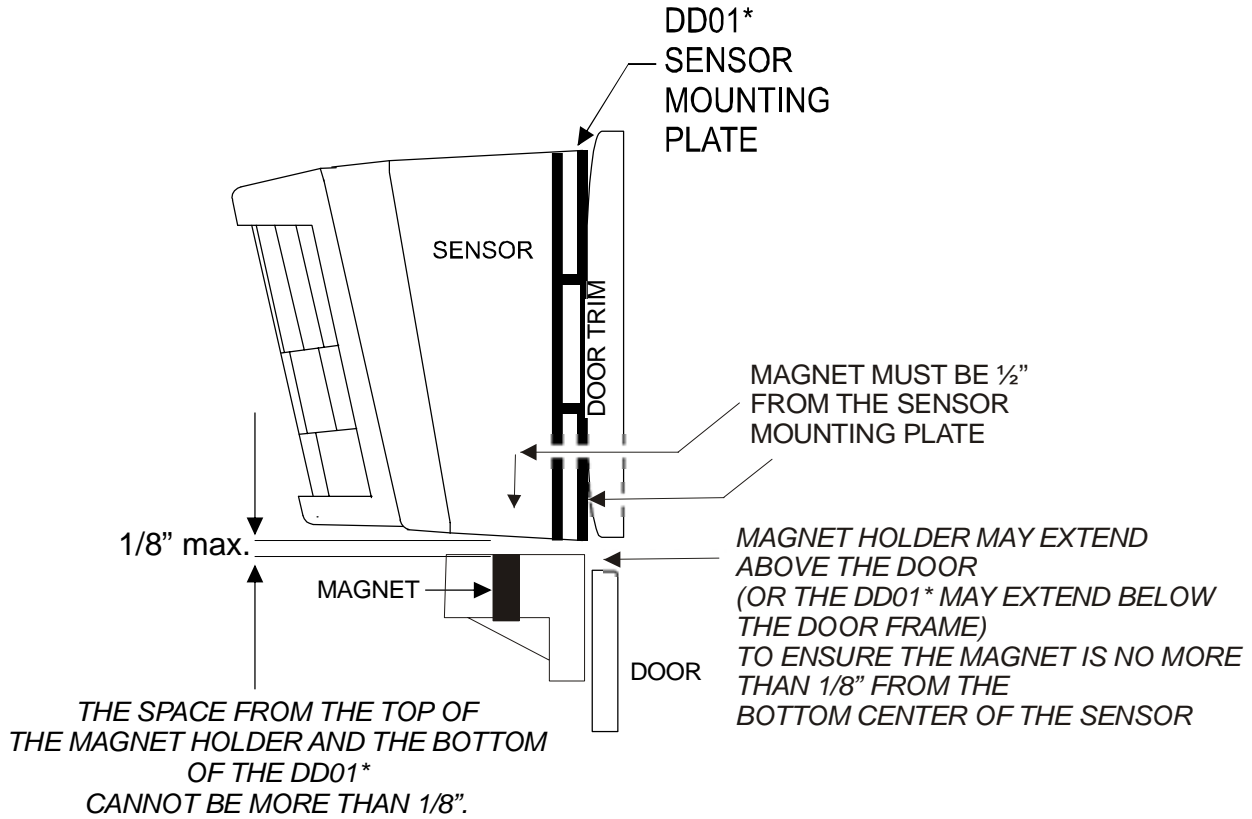

The ideal spacing allows a business card to be easily placed between the DD01* sensor and the magnet holder.

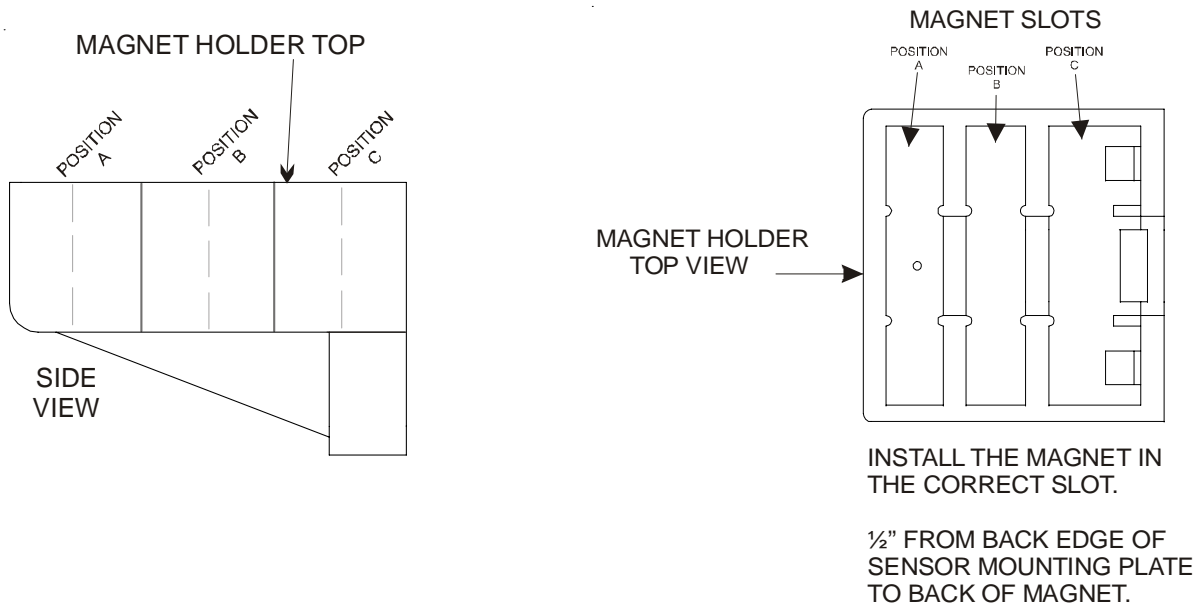

Select one of the three slots that places the magnet $\frac{1}{2}$ " from the sensor mounting plate on the door frame. See examples below. The door frame and door usually will not align. Place holder on the door and select the slot that places the magnet as close as possible to the $\frac{1}{2}$ " depth from the back of the DD01* mounting plate.

POSITION A

Place magnet in Position A in instances when the door trim extends beyond the door.

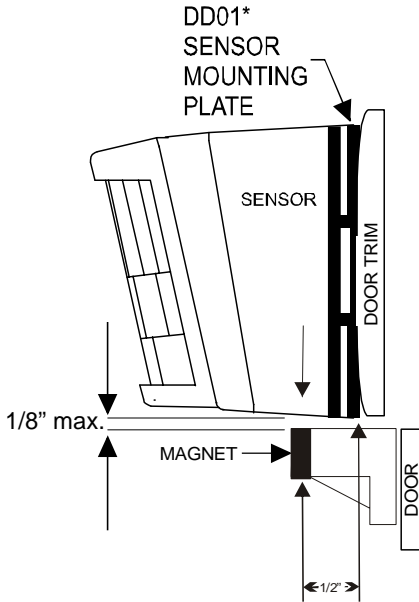

POSITION B

Place magnet in Position B in instances when the door and frame align.

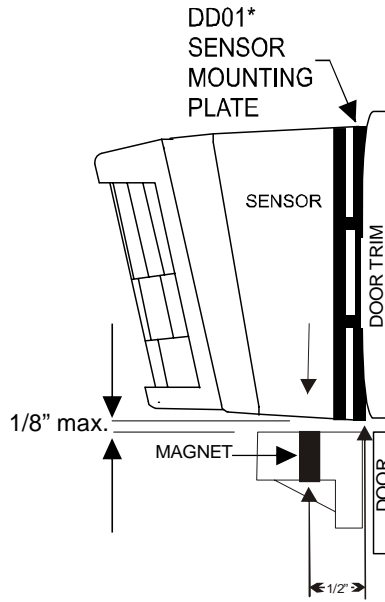

POSITION C

Place magnet in Position C in instances when the door extends beyond the door trim.

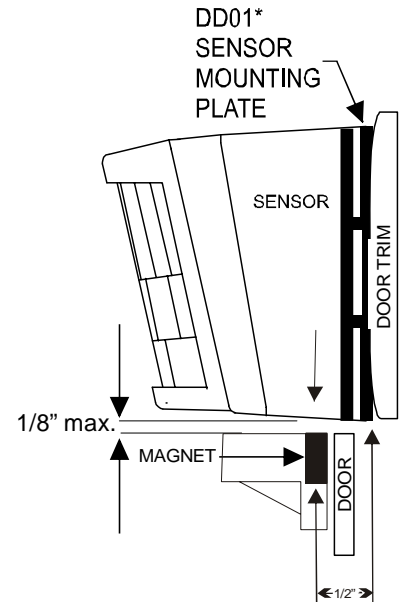

ABOVE SHOWS MAGNET $\frac{1}{2}$ " FROM THE SENSOR MOUNTING PLATE IN DIFFERENT SLOT POSITIONS

Above graphics are for example only. Always measure and place the magnet in the proper slot to obtain the $\frac{1}{2}$ " needed between the magnet and the sensor mounting plate on the door frame.

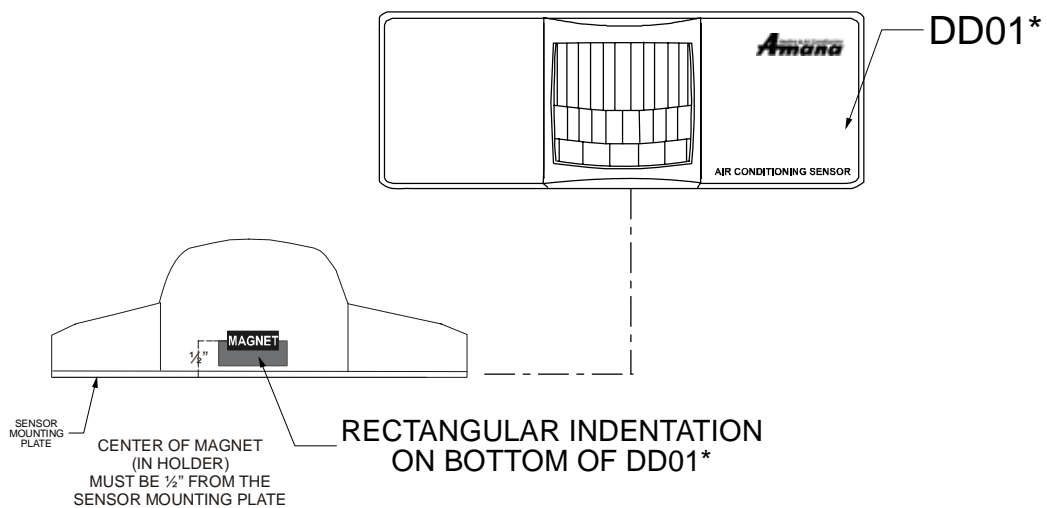

IMPORTANT NOTE: When properly installed, the rectangular indentation on the bottom of the DD01* will line up with the center of the magnet. Choose magnet position A, B or C to align the magnet $\frac{1}{2}$ " from the back of the DD01A*.

Binding of RF Devices



CAUTION

DO NOT HAVE TWO GROUPS OF PEOPLE BINDING UNITS IN THE PROPERTY AT THE SAME TIME. RADIO FREQUENCY (RF) GOES THROUGH WALLS AND UP TO 400'.

DO NOT ATTEMPT TO BIND MORE THAN ONE ROOM AT A TIME AT THE SAME PROPERTY!!!

RF TRANSMITS THROUGH WALLS.



The wireless devices (DS01* and or DD01*) must be bound to the PTAC DT01* control for proper in-room communication. Ensure the unit is powered but in the OFF position.



NOTE: Both the DS01* and the DD01* must be bound to the PTAC unit during the same “learn” operation.



If you need to rebind one device - then you must rebind both devices during the same learn mode event.

All must be bound at one time.

1. Press and hold off button on the PTAC until  appears.

2. Press and then immediately release the white tactile button on the back of the DS01* thermostat.  should now be displayed on the PTAC LED display. If  does not show on the display in 1-2 seconds, then press and release the white button a second time. Skip this step if there is no thermostat.

3. Press and then immediately release the white tactile button on the back of the DD01* motion sensor.  or  should now be displayed on the PTAC LED display.

If  or  does not show on the display in 1-2 seconds, then press and release the white button a second time. **NOTE:** If both a DD01* and a DS01* are being bound, then the display will show .

Skip if there is no motion sensor.

4. Press “OFF” on the PTAC touchpad to exit the binding sequence.

5. Snap thermostat onto thermostat mounting plate.

6. Snap motion sensor onto motion sensor mounting plate.

7. Configure the device or devices that were bound. See the next section for configuration choices.

NOTE: If a wireless device is replaced or added, all devices (including those previously bound) will need to be bound/re-bound to the unit. See directions above.



Configuration Settings

The PTAC control will automatically self-configure to work with the wall thermostat (DS01* Kit) if installed. The PTAC control will automatically self-configure to activate pre-configured energy management routine when the DD01* is installed and bound to the PTAC. Additionally, the setback times and setback temperatures can be changed using the configuration settings. If you are using DP01* Front Desk Platform, the PTAC control will need to be configured to identify its room number placement.

Standard and DS01* Configuration

To enter configuration feature mode:





Press and continue to hold the up and down  arrow keys and quickly press the OFF  key twice within a two (2) second time frame. (On software versions 2.1 or lower - C1 will now be displayed. On version 2.5 or higher - you will see "--" displayed.) Once you are in the configuration program, you can use the HEAT button to move UP the various configuration settings or the COOL button to move DOWN the configuration settings. The + or - keys will move up or down the selectable codes that you can change for each configuration setting. Ensure that you are in the proper configuration setting before pressing the + or - key as you may accidentally change a setting that you did not intent to change.

The display will alternate between displaying the feature code  and the option code 0 (factory default setting). If in version 2.5 or higher - press the HEAT button one time to get into C1 mode and then the display will alternate between C1 and 0 - the factory default. If an RF DS01* has been bound to the unit the display will alternate between C1 and rE. The lower right dot on the display will flash.





Entering Room Number (Skip if not using DP01* Front Desk Platform)

1. The PTAC control can be set for a 4-digit room number. To select the first two digits (floor), press the HEAT 

key until  appears, then press the up  down  arrows to select the first two digits.

2. To select the last two digits of the room number, press the HEAT  key until  appears, then press the up

and down  arrows to select the last 2 digits of the room number.

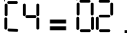
For example for Room "201", press the HEAT  key until  appears, then press the up  down  arrows to select "02": .

Next to select the last two digits of the room number, press the HEAT  key until  appears, then press the

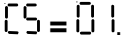
up and down  arrows to select "01": .

Setback Temps - DD01*

The DD01* and the DigiSmart control can be programmed for 3 different times to activate temperature setbacks. The current factory default temperature setbacks in v2.5 * software release are: 2° from set point in 30 minutes, 3° in one (1) hour, and 6° in three (3) hours. For each time, you can select a setback temperature. The amount of setback is the amount of degrees the control will operate from guest's setting in degrees F. If a change to the factory default temperature settings is desired, use the following instructions.

NOTE: When first entering the configuration mode, if you see “ - - ” then you have version 2.5 or higher. You can verify the software version by starting with the unit in the OFF position, and while holding down the “+” and “-” buttons, double click the COOL button and then release and push the FAN button within one second. The unit display will scroll through all of the thermister temperatures and the last item displayed will be CS (current software) and you will see 25 for v2.5.

*Other software versions may have different factory setback defaults. Contact your PTAC representative to determine factory default settings.







WARNING



USE OF SETBACK TEMPERATURES



DO NOT USE MOTION SENSING SETBACK TEMPERATURES IN ROOMS WHERE INCAPACITATED PERSONS OR ANIMALS ARE UNABLE TO CHANGE THE CONTROL SETTING.

AN UNATTENDED AIR CONDITIONER WITH EXTREME SETBACKS MAY RESULT IN UNDESIRABLE OR UNHEALTHY TEMPERATURE IN THE CONDITIONED SPACE, CAUSING UNDER HEATING, UNDER COOLING OR DEATH OF PERSONS OR ANIMALS.



- To select first unoccupied set back temperature, press the **HEAT**  key until  **feature code** comes up. To scroll to a previously viewed feature codes, press the **COOL**  key.



Once you have scrolled to the  feature, press either the up or down arrow  to scroll to the desired first unoccupied setback temperature. Cooling example: 72° (guest set point) + 2° (Setback temperature) = 74° (operational set point).



- Press **HEAT**  key to scroll to  first unoccupied setback time. The first unoccupied setback time is the time between when the control determines that the room is not occupied and when the control sets the operating set point temperature back. The increments are in hours (.1 = 6 mins., .5 = 30 mins., 1 = 1 hour, etc.). Press either the up or down arrow  to the desired first unoccupied setback time. c

- To select second unoccupied setback temperature, press the **HEAT**  key until  comes up. Press either the up or down arrow  to the desired second unoccupied setback temperature.

Cooling example: 72° (guest set point) + 4° (Setback temperature) = 76° (operational set point).

7. Press **HEAT**  key to scroll to  second unoccupied setback time. Press either the up or down arrow  to the desired second unoccupied setback time. Example: Operating set point would be 76° instead of 72, one hour (1.0 hour) after guest leaves room.

8. Press **HEAT**  key to scroll to  third unoccupied setback temperature. Press either the up or down arrow  to the desired third unoccupied setback temperature.

9. Press **HEAT**  key to scroll to  third unoccupied setback time. Press either the up or down arrow  to the desired third unoccupied setback time.

10.. To **exit configuration mode**:

Press the **OFF**  key. **NOTE:** Configuration feature mode will also automatically exit **if no keys are pressed** for a period of **two (2) minutes**.

The changes made in configuration mode are now in effect.

NOTE: Additional codes are present and may be accessed within this menu. Contact the manufacturer for additional information.

Typical Room Layouts

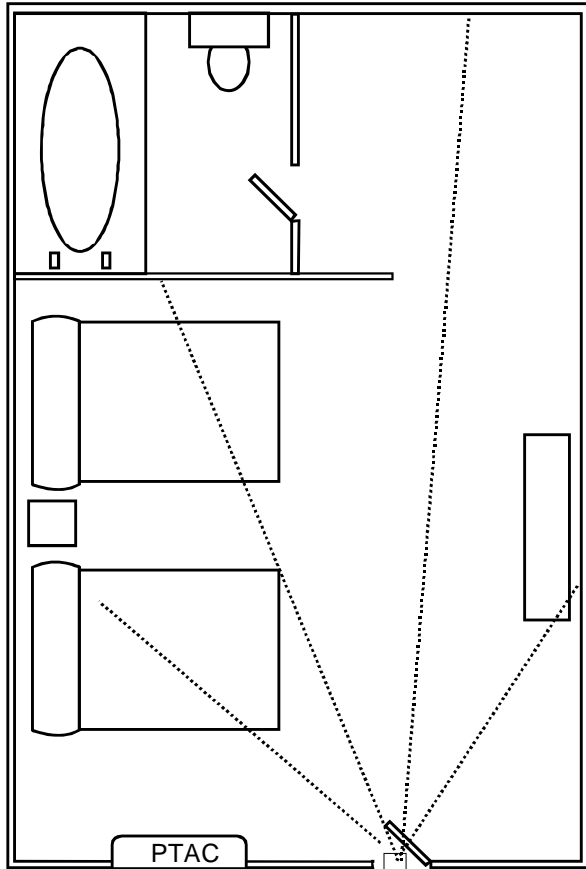

MOTION
SENSOR
OUTSIDE

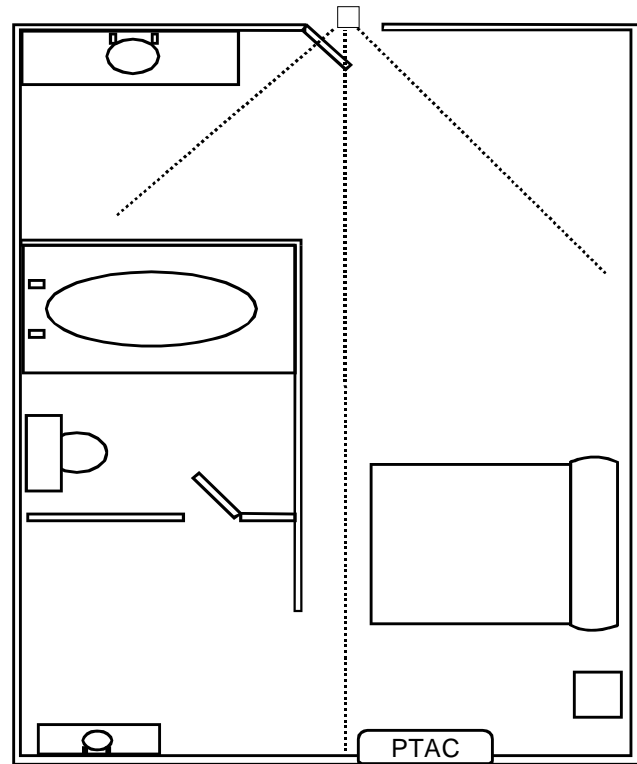

MOTION
SENSOR
OUTSIDE



CAUTION

This equipment is authorized for use under the United States Federal Communication Commission Rules and Regulations, Code of Federal Regulations Chapter 47 part 15 and must be installed in accordance with the instructions provided in this document. Failure to install or operate this equipment as instructed in this document could void the user's authority to operate the equipment. This equipment contains no user servicable parts. Any modification or repairs to the internal components or to the antenna configuration of the equipment without the express written consent of Everex Communications, Inc. could void the user's authority to operate the equipment.

NOTE: This equipment has been tested and found to comply with the limits for a Class B digital device, pursuant to Part 15 of the FCC Rules. These limits are designed to provide reasonable protection against harmful interference in a residential installation. This equipment generates, uses and can radiate radio frequency energy and, if not installed and used in accordance with the instructions, may cause harmful interference to radio communications. However, there is no guarantee that interference will occur in a particular installation. If this equipment does cause harmful interference to radio or television reception, which can be determined by turning the equipment off and on, the user is encouraged to try to correct the interference by one or more of the following measures:

- Reorient or relocate the receiving antenna.
- Increase the separation between the equipment and receiver.
- Connect the equipment into an outlet on a circuit different from that to which the receiver is connected.
- Consult the dealer or an experienced radio/TV technician for help.

NOTE: To comply with FCC RF exposure requirements in section 1.1307, a minimum separation distance of 20cm (8 inches) is required between the equipment and all persons.

THIS PAGE INTENTIONALLY LEFT BLANK

Due to policy of continued product improvement, the right is reserved to change specifications and design without notice.

Amana is a trademark of Maytag Corporation and is used under license to Goodman Company, L.P. All rights reserved.

Goodman Company, L.P.
5151 San Felipe, Suite 500 • Houston, TX 77056

www.amana-ptac.com

© 2005 - 2007 Goodman Company, L.P.